

ZONE		REV	DESCRIPTION	DATE	APPROVED
-	NC		INITIAL RELEASE		

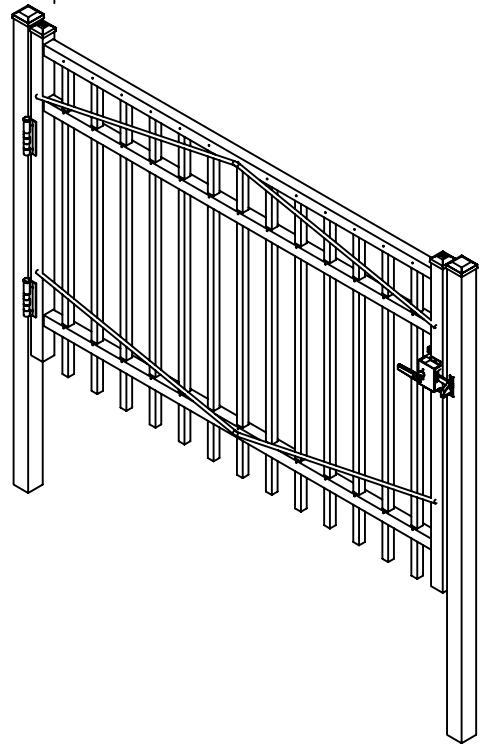

*Jerith*<sup>®</sup>  
 Manufacturing Co., Inc.  
 Philadelphia, PA 19154  
 (800)344-2242

DRAWING:  
**INDUSTRIAL GATE**  
**STYLE #202**  
**48" HIGH X 72" WIDE**

SIZE D	DWG NO. IN48U20272	REV NC
SCALE	DATE 8-6-08	SHEET 1 OF 1

© 2004. This drawing may not be altered or reproduced without the permission of Jerith Manufacturing Co., Inc.